

4

3

2

1

REVISION HISTORY			
REV	DESCRIPTION	APPROVED	DATE
-			

B

A

B

A

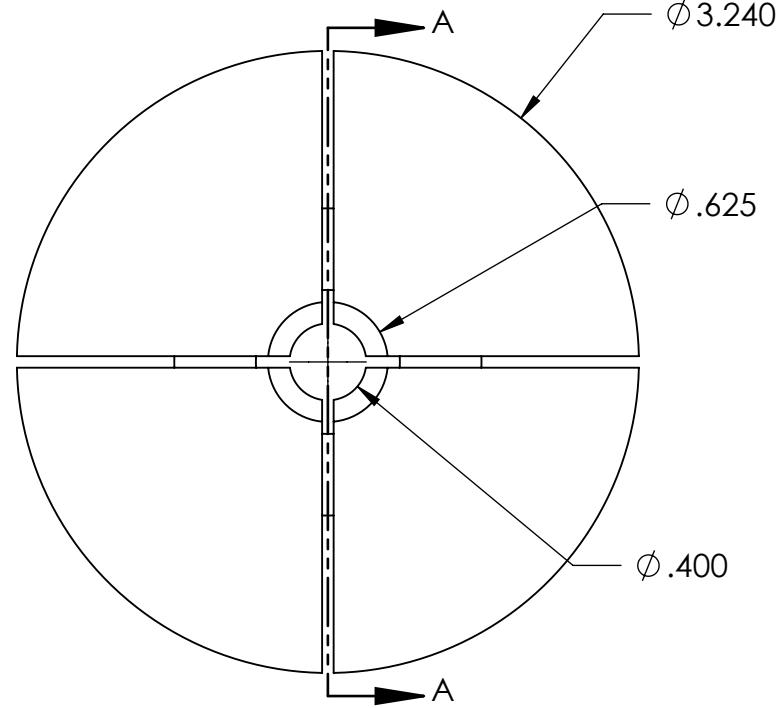
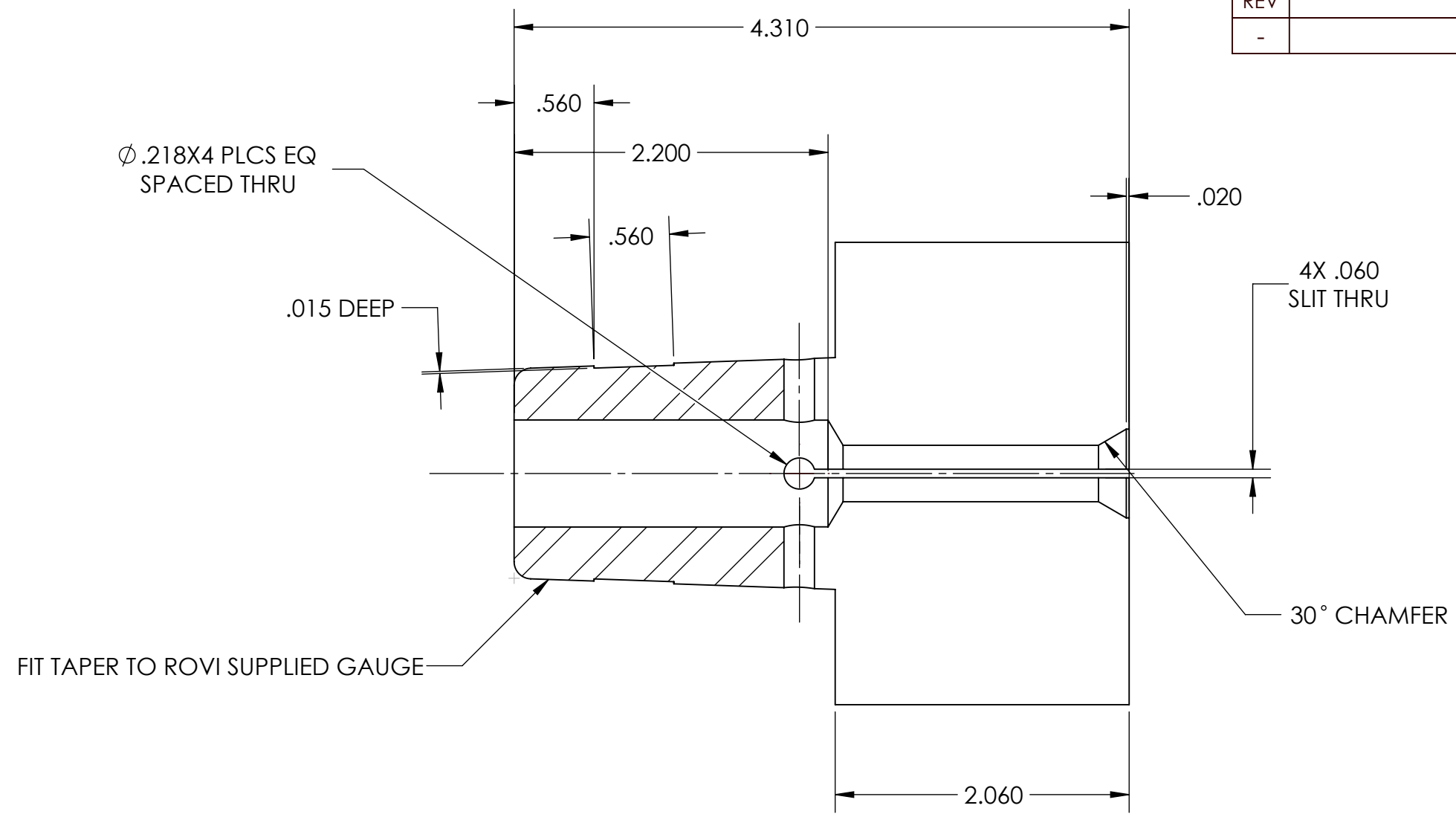

SECTION A-A
SCALE 1 : 1

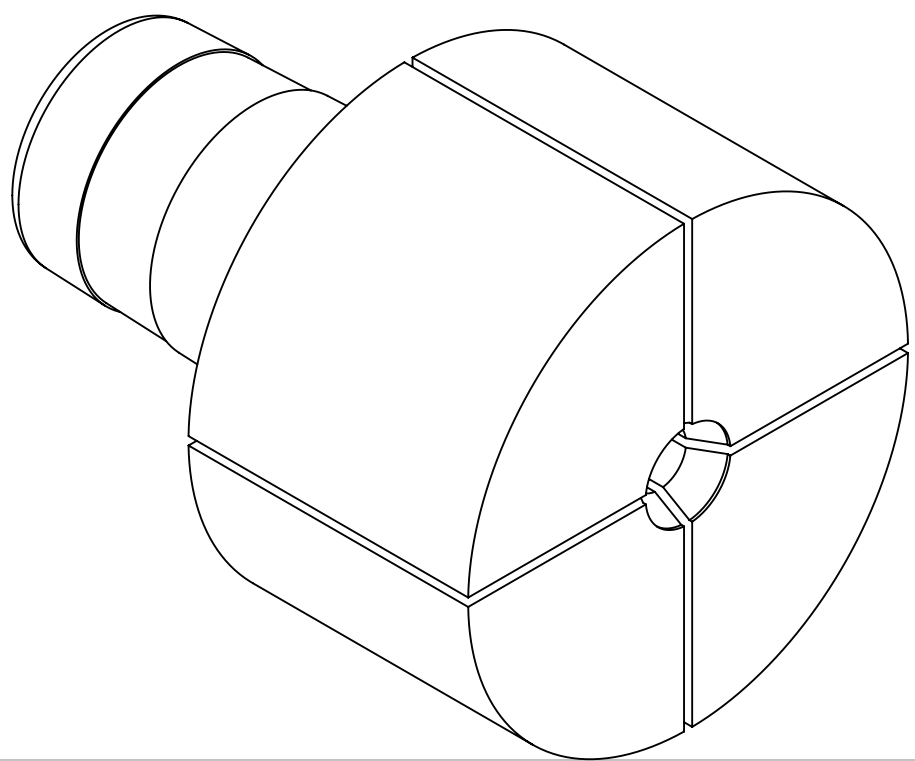

UNLESS OTHERWISE SPECIFIED:	NAME	DATE
DIMENSIONS ARE IN INCHES	DRAWN R. PEREZ	09/03/22
ANGULAR ±.5°	CHECKED	
TWO PLACE DECIMAL ±.01	ENG APPR.	
THREE PLACE DECIMAL ±.003	MFG APPR.	
FILLET RADII .015 MAX	Q.A.	
BREAK CORNERS .005/.010		
ALL Ø CONC WITHIN .005 T.I.R.		
SURFACE FINISH 125/√	THIRD ANGLE PROJECTION	
INTERPRET DRAWING PER: ASME Y14.5-2009		
DO NOT SCALE DRAWING		

PROPRIETARY AND CONFIDENTIAL
THE INFORMATION CONTAINED IN THIS DRAWING IS THE SOLE PROPERTY OF ROVI PRODUCTS INC. ANY REPRODUCTION IN PART OR AS A WHOLE WITHOUT THE WRITTEN PERMISSION OF ROVI PRODUCTS INC IS PROHIBITED.

rovi PRODUCTS INCORPORATED
ROVI PRODUCTS INC
4648 RUNWAY ST #B
SIMI VALLEY, CA 93063

TITLE:
EXPANDING COLLET, KEY DIMENSIONS

SIZE	DWG. NO.	REV
B	3.5X2-8	---

SCALE: 1:1 WEIGHT: 5.425 LBS SHEET 1 OF 1

4

3

2

1